

# QUICK START GUIDE

## 4.3 inch FacialTime Attendance Terminal

### Safety Precautions

Before installation, please read the following safety precautions for user safety and to prevent product damage.

- Do not install the device in a place subject to direct sun light, humidity, dust or soot.
- Do not place magnet near the device. Magnetic objects such as magnet, CRT, TV, monitor or speaker may damage the device.
- Do not place the device next to heating equipment.
- Do not let liquid like water, drinks or chemicals leak inside the device.
- Do not let children touch the device without supervision.
- Do not drop or damage the device.
- Do not disassemble, repair or alter the device.
- Do not use the device for any purpose other than those specified.
- Clean the device often to remove dust on it. While cleaning, do not splash water on the device but wipe it out with smooth cloth or towel.

Contact your supplier in case of a problem!

### User Registration

1) Recommended Standing Position

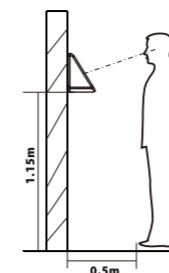

For user heights between 1.5m to 1.8m, it is recommended to install the device at 1.15m height above ground (may be modified according to user average height).

a. Recommended Registration and Verification Position

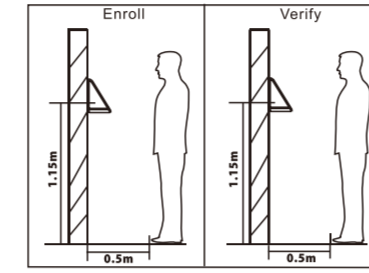

Recommended Procedures (as shown in the left image): During registration and verification procedures, the position of device should not be changed to prevent reduction in verification preciseness. If it is necessary to move the device, its vertical height should not be changed.

b. Factors Affecting the Preciseness of Verification

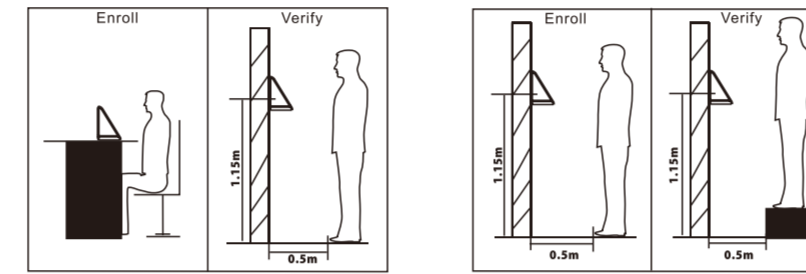

Non-identical registration and verification gestures

Non-identical registration and verification heights

### User Registration

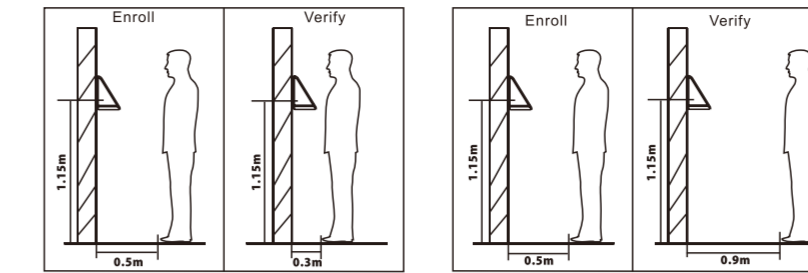

Non-identical registration and verification distances from device

Non-identical registration and verification distances from device

2) Recommended face Expressions vs. poor Expressions:

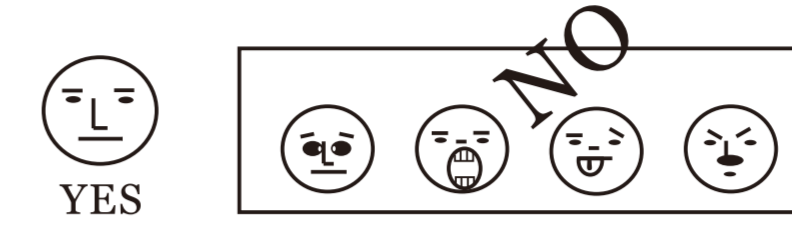

3) Registration

- a. During registration, it is required to adjust your upper body to fit your eyes into the green frame on the screen.
- b. During verification, it is required to show your face in the center of the screen and fit your eyes into the green frame on the screen.



### Device Overview

Front

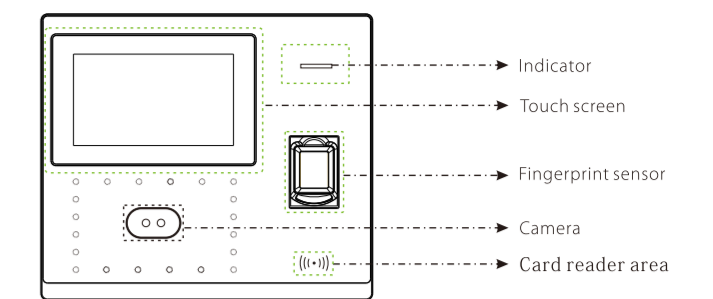

Left Side

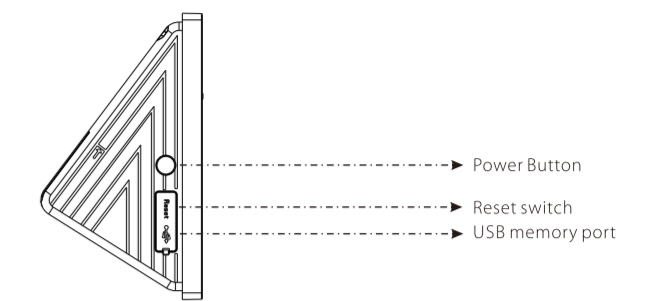

Back

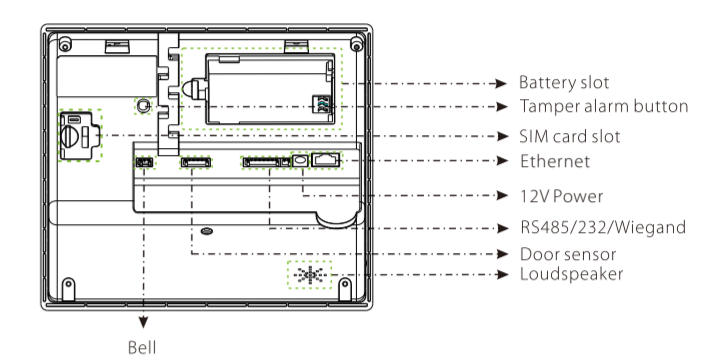

### Device Dimensions & Installation

Product dimensions

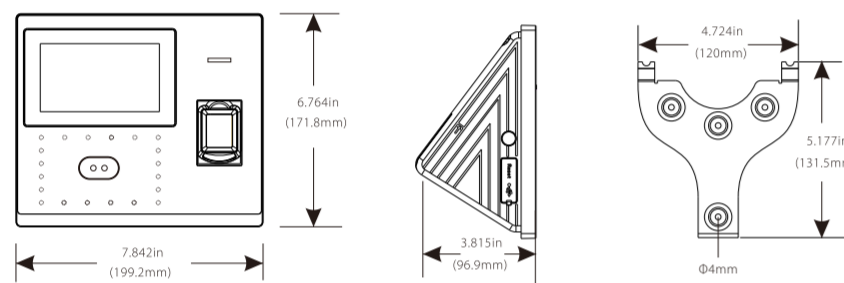

Mounting the device on wall

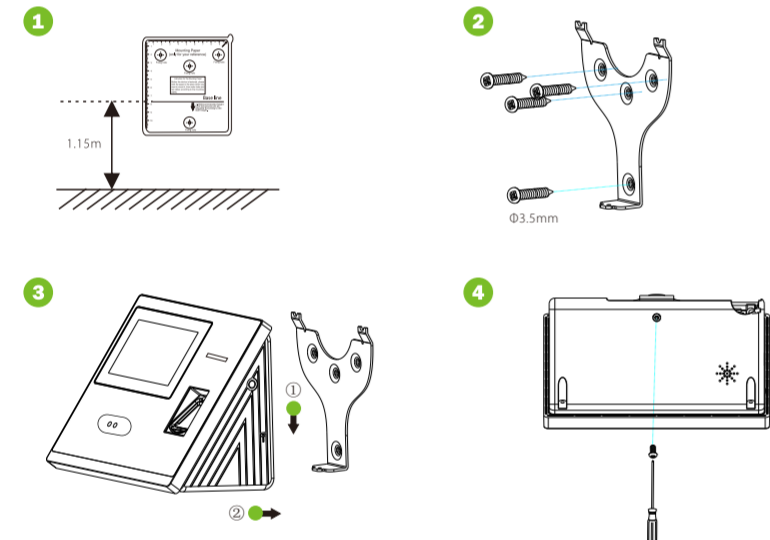

- 1 Paste the mounting template sticker onto the wall, and drill holes according to the mounting paper.
- 2 Fix the back plate onto the wall using wall mounting screws.
- 3 Insert the device into back plate.
- 4 Use security screw to fasten the device to back plate.

5

### Bell Connection

External bell normally opened connection

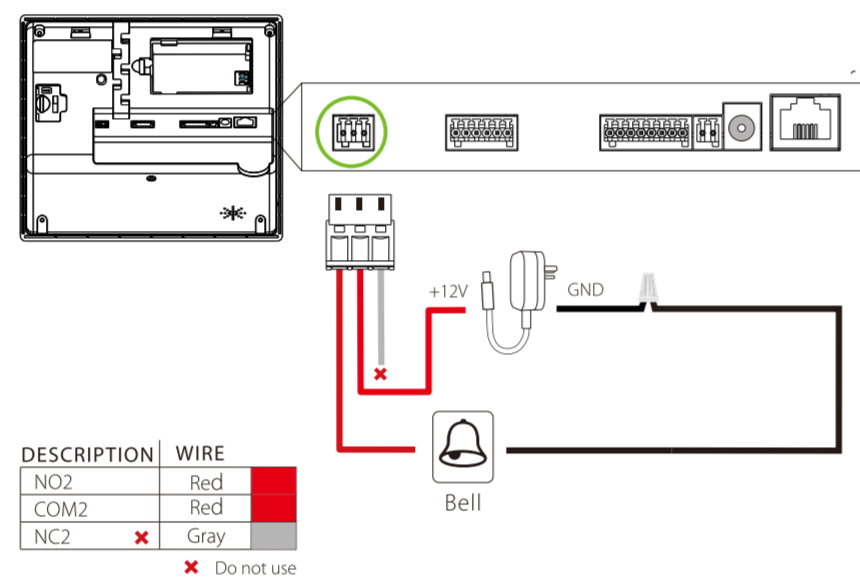

External bell normally closed connection

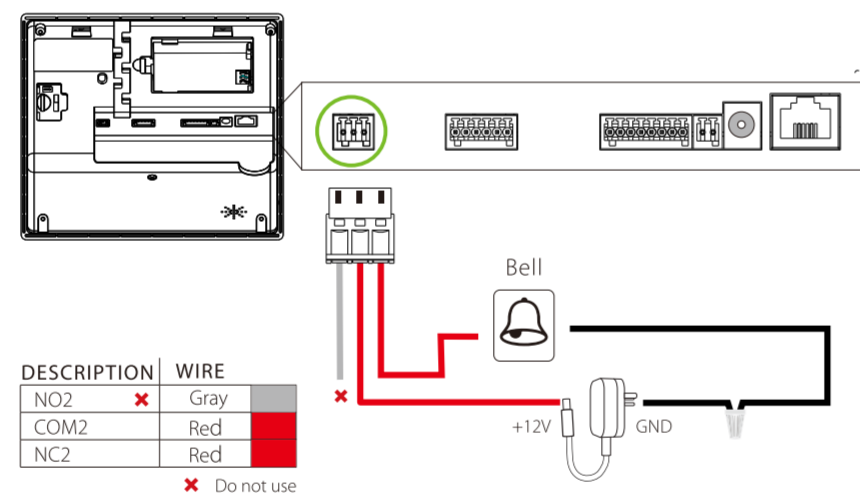

6

### Lock Relay Connection

The system supports Normally Opened Lock and Normally Closed Lock (normally opened)

Device not sharing power with the lock

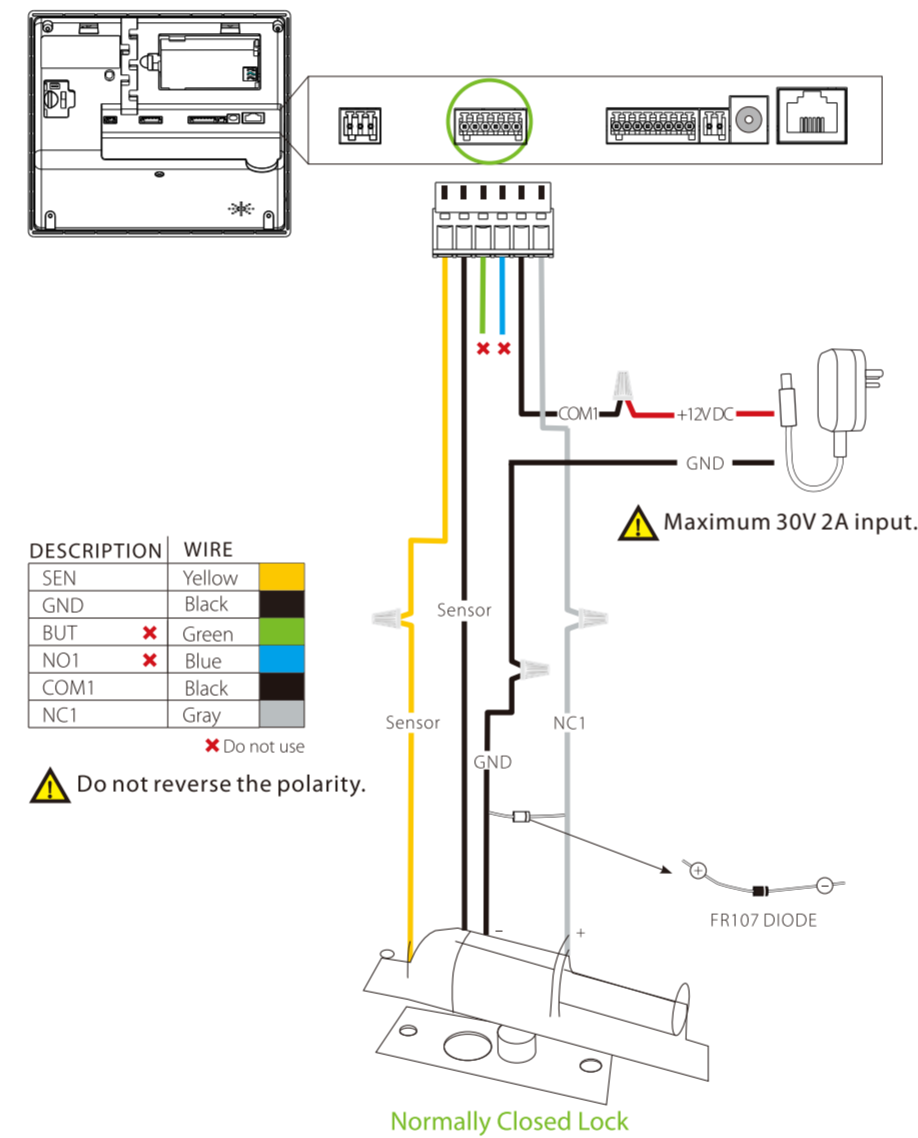

7

### Lock Relay Connection

Device sharing power with the lock

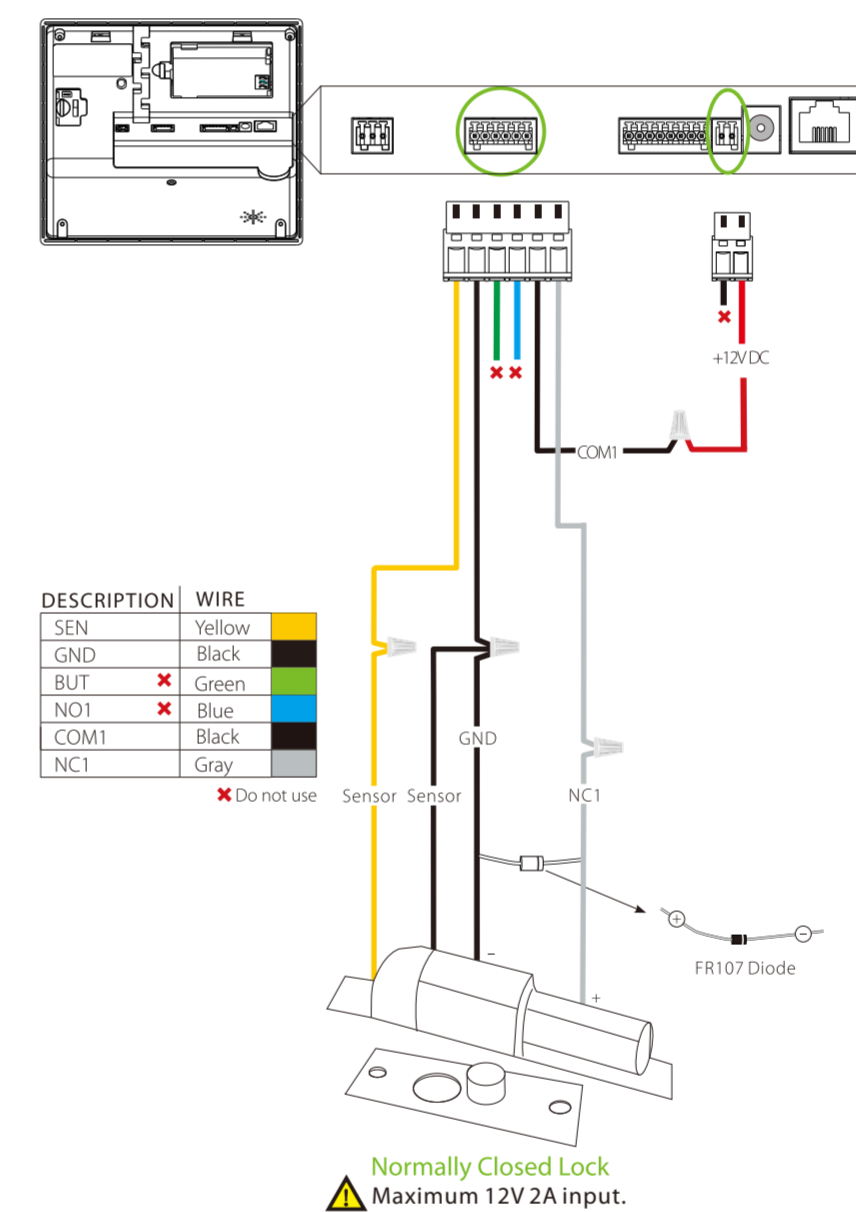

8

### Ethernet Connection

Connecting the device to PC via cross cable

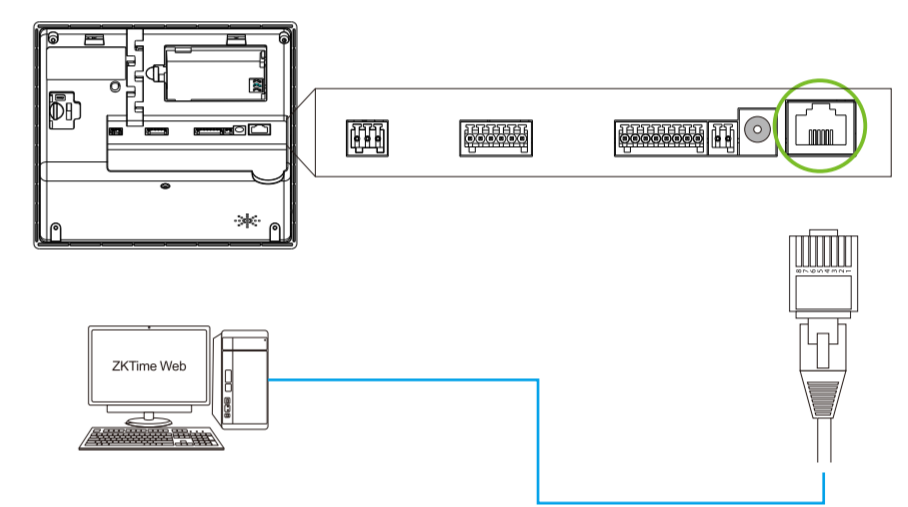

Connecting the device to PC via the CAT-5 cable and switch to create a local network

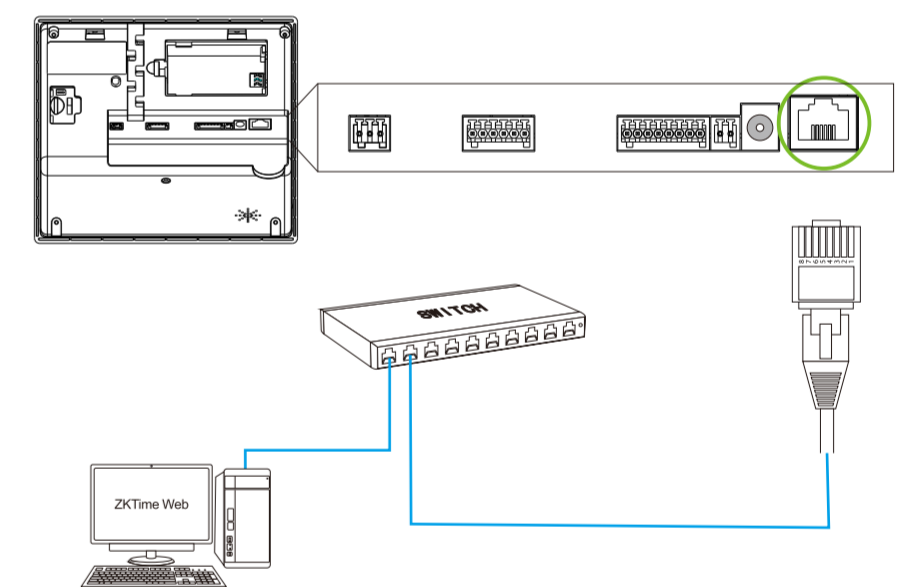

9

### RS232 Connection

Printer connection

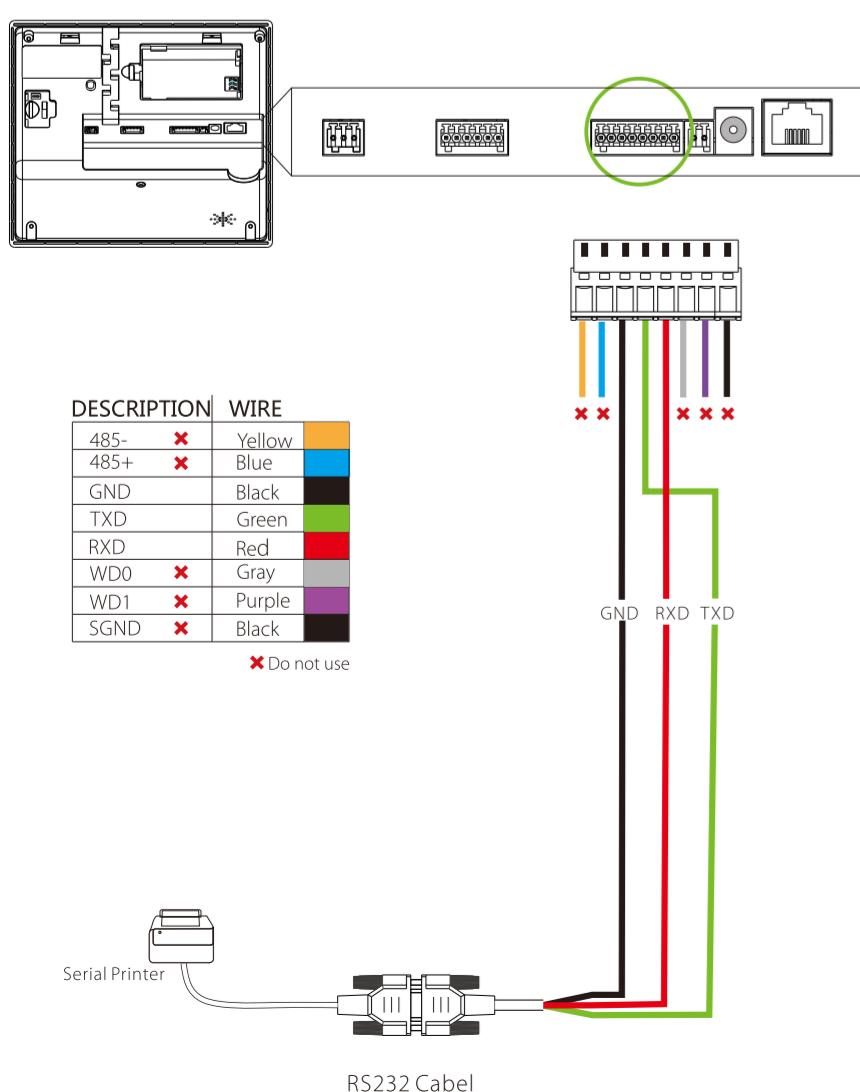

10

### Wiegand Output Connection

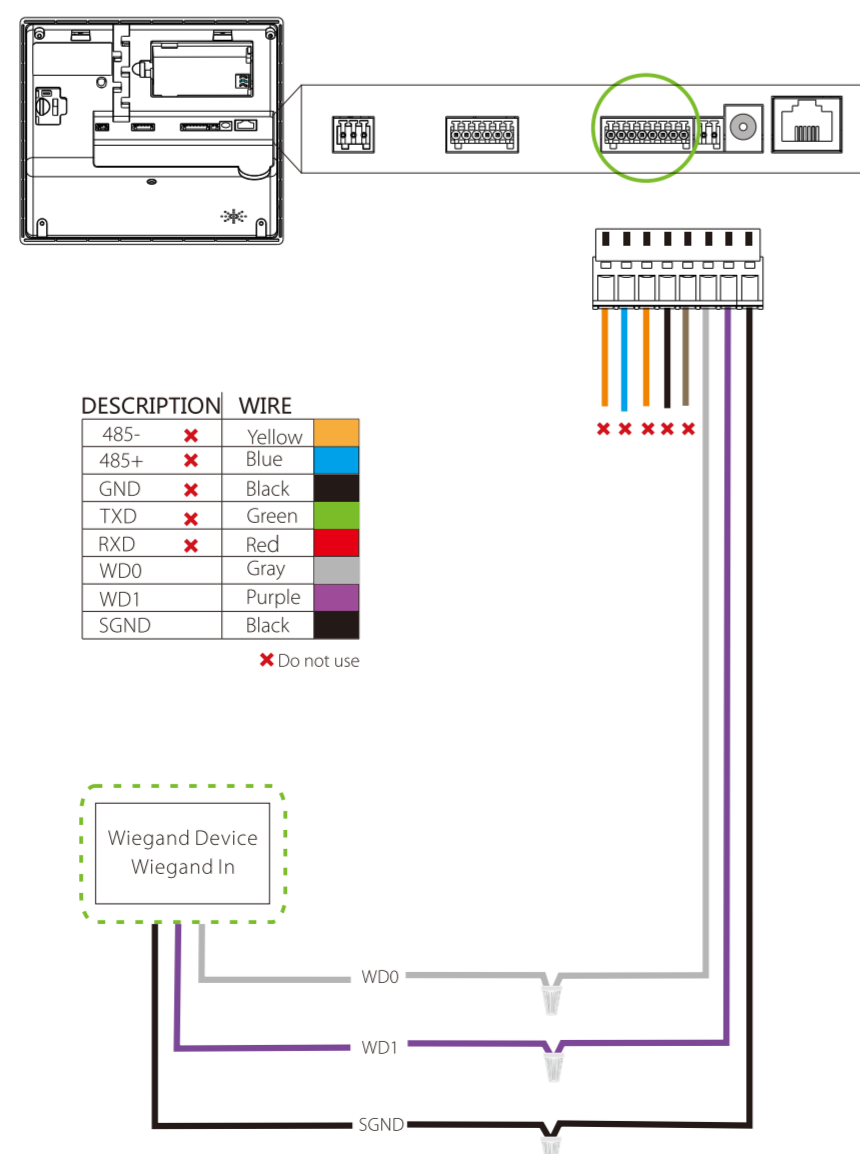

11

### Power Connection

With UPS (Optional)

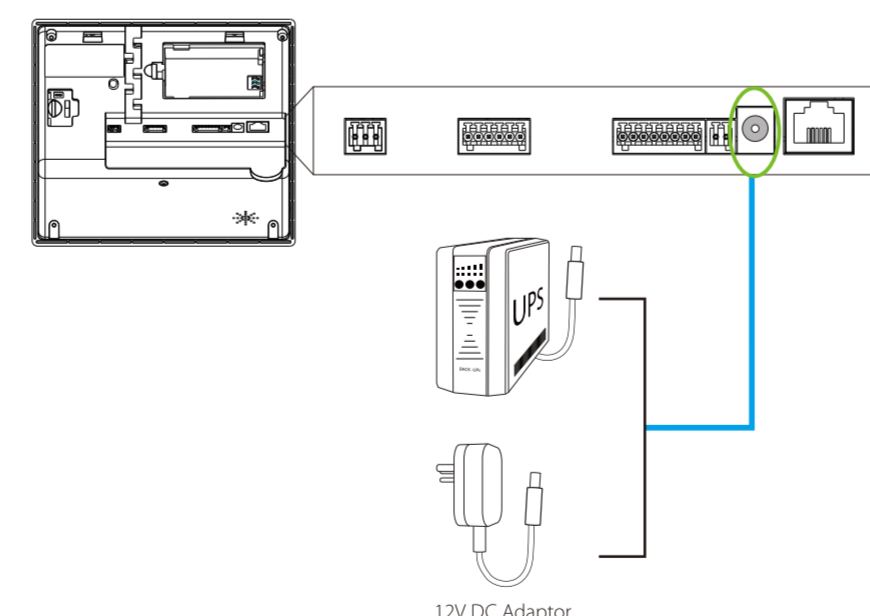

Without UPS

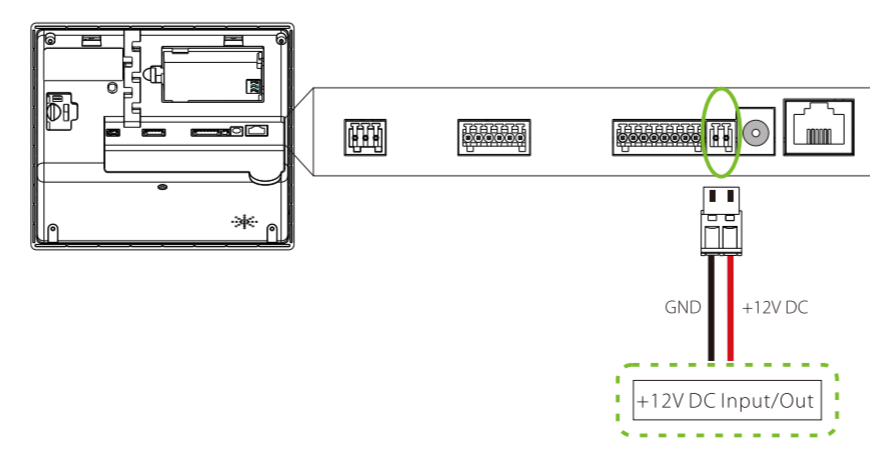

12

### Standalone Installation

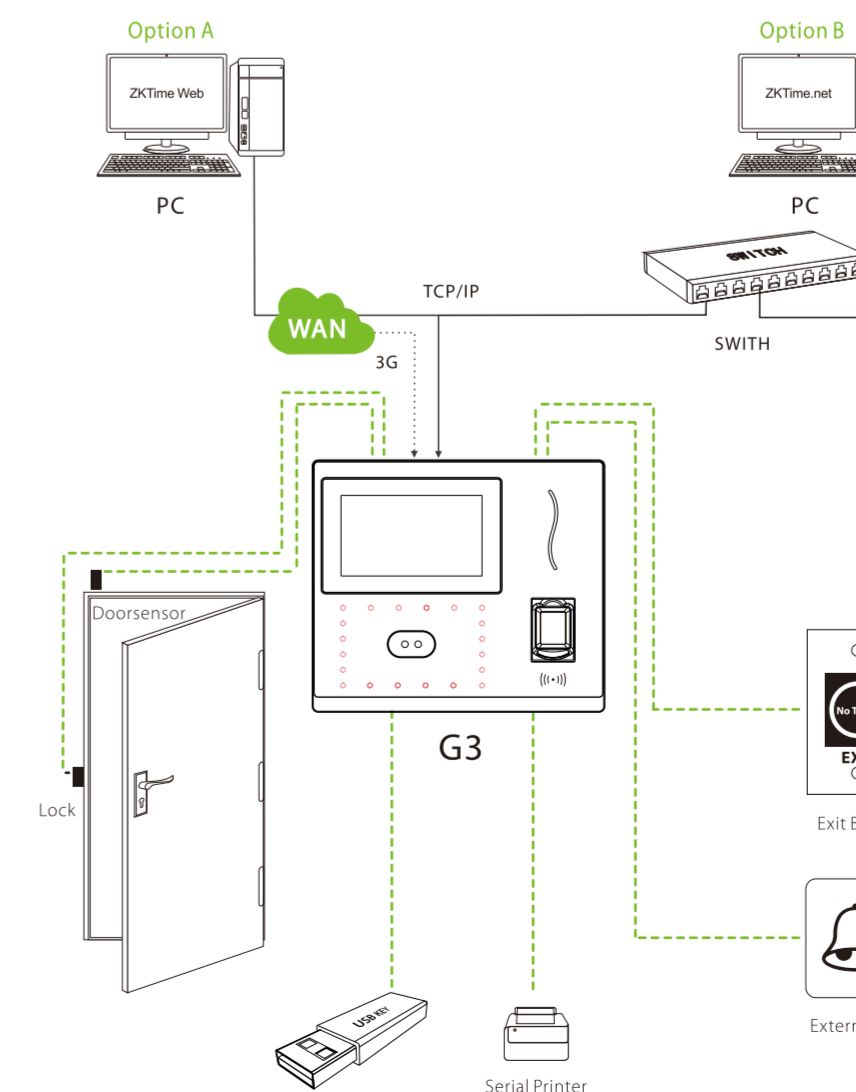

13

ZK Building, Wuhe Road, Gangtuo, Bantian, Biji Town,  
Longgange District, Shenzhen China 518129  
Tel: +86 755-89602345  
Fax: +86 755-89602394  
www.zkteco.com



© Copyright 2015 ZKTeco Inc. ZKTeco Logo is a registered trademark of ZKTeco or related company. All other product and company names mentioned are used for identification purposes only and may be the trademarks of their respective owners. All specifications are subject to change without notice. All rights reserved.