



# 2 MP Full Time Color Camera

## User Manual

### User Manual

Thank you for purchasing our product. If there are any questions, or requests, do not hesitate to contact the dealer.

This manual applies to the models below:

Type	Model
Type I Camera	DS-2CE10DF0T-F
	DS-2CE10DF0T-PF
Type II Camera	DS-2CE12DF0T-F
Type III Camera	DS-2CE70DF0T-PF
Type IV Camera	DS-2CE70DF0T-MF
Type V Camera	DS-2CE72DF0T-F

This manual may contain several technical mistakes or printing errors, and the content is subject to change without notice. The updates will be added to the new version of this manual. We will readily improve or update the products or procedures described in the manual.

01040020241009

## About this Document

- This Document includes instructions for using and managing the Product. Pictures, charts, images and all other information hereinafter are for description and explanation only.
- The information contained in the Document is subject to change, without notice, due to firmware updates or other reasons. Please find the latest version of the Document at the Hikvision website (<https://www.hikvision.com>). Unless otherwise agreed, Hangzhou Hikvision Digital Technology Co., Ltd. or its affiliates (hereinafter referred to as "Hikvision") makes no warranties, express or implied.
- Please use the Document with the guidance and assistance of professionals trained in supporting the Product.

## About this Product

This product can only enjoy the after-sales service support in the country or region where the purchase is made.

## Acknowledgment of Intellectual Property Rights

- Hikvision owns the copyrights and/or patents related to the technology embodied in the Products described in this Document, which may include licenses obtained from third parties.
- Any part of the Document, including text, pictures, graphics, etc., belongs to Hikvision. No part of this Document may be excerpted, copied, translated, or modified in whole or in part by any means without written permission.
- **HIKVISION** and other Hikvision's trademarks and logos are the properties of Hikvision in various jurisdictions.
- Other trademarks and logos mentioned are the properties of their respective owners.

## LEGAL DISCLAIMER

- TO THE MAXIMUM EXTENT PERMITTED BY APPLICABLE LAW, THIS DOCUMENT AND THE PRODUCT DESCRIBED, WITH ITS HARDWARE, SOFTWARE AND FIRMWARE, ARE PROVIDED "AS IS" AND "WITH ALL FAULTS AND ERRORS". HIKVISION MAKES NO WARRANTIES, EXPRESS OR IMPLIED, INCLUDING WITHOUT LIMITATION, MERCHANTABILITY, SATISFACTORY QUALITY, OR FITNESS FOR A PARTICULAR PURPOSE. THE USE OF THE PRODUCT BY YOU IS AT YOUR OWN RISK. IN NO EVENT WILL HIKVISION BE LIABLE TO YOU FOR ANY SPECIAL, CONSEQUENTIAL, INCIDENTAL, OR INDIRECT DAMAGES, INCLUDING, AMONG OTHERS, DAMAGES FOR LOSS OF BUSINESS PROFITS, BUSINESS INTERRUPTION, OR LOSS OF DATA, CORRUPTION OF SYSTEMS, OR LOSS OF DOCUMENTATION, WHETHER BASED ON BREACH OF CONTRACT, TORT (INCLUDING NEGLIGENCE), PRODUCT LIABILITY, OR OTHERWISE, IN CONNECTION WITH THE USE OF THE PRODUCT, EVEN IF HIKVISION HAS BEEN ADVISED OF THE POSSIBILITY OF SUCH DAMAGES OR LOSS.
- YOU ACKNOWLEDGE THAT THE NATURE OF THE INTERNET PROVIDES FOR INHERENT SECURITY RISKS, AND HIKVISION SHALL NOT TAKE ANY RESPONSIBILITIES FOR ABNORMAL OPERATION, PRIVACY LEAKAGE OR OTHER DAMAGES RESULTING FROM CYBER-ATTACK, HACKER ATTACK, VIRUS INFECTION, OR OTHER INTERNET SECURITY RISKS; HOWEVER, HIKVISION WILL PROVIDE TIMELY TECHNICAL SUPPORT IF REQUIRED.
- YOU AGREE TO USE THIS PRODUCT IN COMPLIANCE WITH ALL APPLICABLE LAWS, AND YOU ARE SOLELY RESPONSIBLE FOR ENSURING THAT YOUR USE CONFORMS TO THE APPLICABLE LAW. ESPECIALLY,

YOU ARE RESPONSIBLE, FOR USING THIS PRODUCT IN A MANNER THAT DOES NOT INFRINGE ON THE RIGHTS OF THIRD PARTIES, INCLUDING WITHOUT LIMITATION, RIGHTS OF PUBLICITY, INTELLECTUAL PROPERTY RIGHTS, OR DATA PROTECTION AND OTHER PRIVACY RIGHTS. YOU SHALL NOT USE THIS PRODUCT FOR ANY PROHIBITED END-USES, INCLUDING THE DEVELOPMENT OR PRODUCTION OF WEAPONS OF MASS DESTRUCTION, THE DEVELOPMENT OR PRODUCTION OF CHEMICAL OR BIOLOGICAL WEAPONS, ANY ACTIVITIES IN THE CONTEXT RELATED TO ANY NUCLEAR EXPLOSIVE OR UNSAFE NUCLEAR FUEL-CYCLE, OR IN SUPPORT OF HUMAN RIGHTS ABUSES.

- IN THE EVENT OF ANY CONFLICTS BETWEEN THIS DOCUMENT AND THE APPLICABLE LAW, THE LATTER PREVAILS.

© Hangzhou Hikvision Digital Technology Co., Ltd. All rights reserved.

## Regulatory Information

### FCC Information

Please take attention that changes or modification not expressly approved by the party responsible for compliance could void the user's authority to operate the equipment.

**FCC compliance:** This equipment has been tested and found to comply with the limits for a Class A digital device, pursuant to part 15 of the FCC Rules. These limits are designed to provide reasonable protection against harmful interference when the equipment is operated in a commercial environment. This equipment generates, uses, and can radiate radio frequency energy and, if not installed and used in accordance with the instruction manual, may cause harmful interference to radio communications. Operation of this equipment in a residential area is likely to cause harmful interference in which case the user will be required to correct the interference at his own expense.

### FCC Conditions

This device complies with part 15 of the FCC Rules. Operation is subject to the following two conditions:

1. This device may not cause harmful interference.
2. This device must accept any interference received, including interference that may cause undesired operation.

### EU Conformity Statement



This product and - if applicable - the supplied accessories too are marked with "CE" and comply therefore with the applicable harmonized European standards listed under the Low Voltage Directive 2014/35/EU, the EMC Directive 2014/30/EU, the RoHS Directive 2011/65/EU.

2012/19/EU (WEEE directive): Products marked with this symbol cannot be disposed of as unsorted municipal waste in the European Union. For proper recycling, return this product to your local supplier upon the purchase of equivalent new equipment, or dispose of it at designated collection points. For more information see: [www.recyclethis.info](http://www.recyclethis.info).



2006/66/EC (battery directive): This product contains a battery that cannot be disposed of as unsorted municipal waste in the European Union. See the product documentation for specific battery information. The battery is marked with this symbol, which may



include lettering to indicate cadmium (Cd), lead (Pb), or mercury (Hg). For proper recycling, return the battery to your supplier or to a designated collection point. For more information, see: [www.recyclethis.info](http://www.recyclethis.info).

### Industry Canada ICES-003 Compliance

This device meets the CAN ICES-3 (A)/NMB-3(A) standards requirements.

### Warning

This is a class A product. In a domestic environment this product may cause radio interference in which case the user may be required to take adequate measures.



### Safety Instruction

These instructions are intended to ensure that user can use the product correctly to avoid danger or property loss.

The precaution measure is divided into “Warnings” and “Cautions”.

**Warnings:** Serious injury or death may occur if any of the warnings are neglected.

**Cautions:** Injury or equipment damage may occur if any of the cautions are neglected.

	
<b>Warnings</b> Follow these safeguards to prevent serious injury or death.	<b>Cautions</b> Follow these precautions to prevent potential injury or material damage.



### Warnings

- In the use of the device, you must be in strict compliance with the electrical safety regulations of the nation and region.
- Input voltage should meet both the SELV (Safety Extra Low Voltage) and the Limited Power Source with 12 VDC according to the IEC60950-1 and IEC62368-1 standard. Refer to technical specifications for detailed information.
- Do not connect multiple devices to one power adapter to avoid over-heating or a fire hazard caused by overload.
- Make sure that the plug is firmly connected to the power socket.
- Make sure that the device is firmly fixed if wall mounting or ceiling mounting is adopted.
- If smoke, odor or noise rise from the device, turn off the power at once and unplug the power cord, and then contact the service center.
- Never attempt to disassemble the camera by unprofessional personal.



### Cautions

- Do not drop the camera or subject it to physical shock.
- Do not touch sensor modules with fingers.

- Do not place the camera in extremely hot, cold (the operating temperature shall be  $-40^{\circ}\text{C}$  to  $60^{\circ}\text{C}$ ), dusty or damp locations, and do not expose it to high electromagnetic radiation.
- If cleaning is necessary, use clean cloth with a bit of ethanol and wipe it gently.
- Do not aim the camera at the sun or extra bright places.
- The sensor may be burned out by a laser beam, so when any laser equipment is in using, make sure that the surface of sensor will not be exposed to the laser beam.
- Do not expose the device to high electromagnetic radiation or extremely hot, cold, dusty or damp environment.
- To avoid heat accumulation, good ventilation is required for the operating environment.
- Keep the camera away from liquid while in use for non-water-proof device.
- While in delivery, the camera shall be packed in its original packing, or packing of the same texture.

## Mark Description

Table 0-1 Mark Description

Mark	Description
---	DC Voltage

# 1 Introduction

## 1.1 Product Features

The main features are as follows:

- High performance CMOS sensor
- OSD menu with configurable parameters
- 24-hour color image
- Smart light
- 3-axis adjustment

## 1.2 Overview

### 1.2.1 Overview of Type I Camera

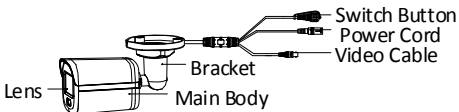

Figure 1-1 Overview of Type I Camera

#### Note:

Press and hold the switch button for 5 seconds to switch the video output. Four kinds of video outputs are available: TVI, AHD, CVI, and CVBS

### 1.2.2 Overview of Type II Camera

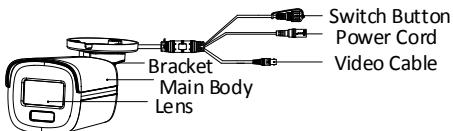

Figure 1-2 Overview of Type II Camera

#### Note:

Press and hold the switch button for 5 seconds to switch the video output. Four kinds of video outputs are available: TVI, AHD, CVI, and CVBS.

### 1.2.3 Overview of Type III Camera

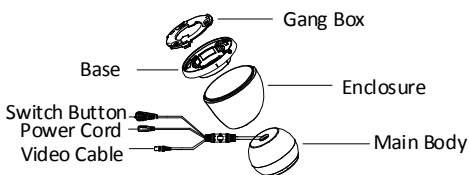

Figure 1-3 Overview of Type III Camera

**Note:**

Press and hold the switch button for 5 seconds to switch the video output. Four kinds of video outputs are available: TVI, AHD, CVI, and CVBS.

### 1.2.4 Overview of Type IV Camera

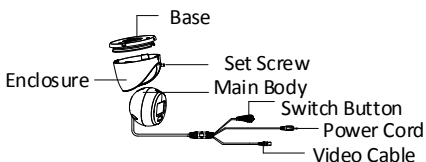

Figure 1-4 Overview of Type IV Camera

**Note:**

Press and hold the switch button for 5 seconds to switch the video output. Four kinds of video outputs are available: TVI, AHD, CVI, and CVBS.

### 1.2.5 Overview of Type V Camera

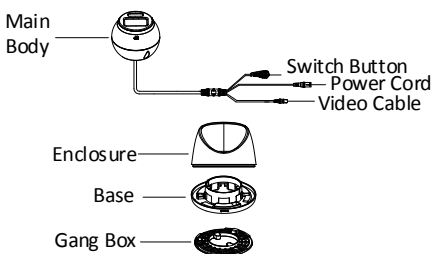

Figure 1-5 Overview of Type V Camera

**Note:**

Press and hold the switch button for 5 seconds to switch the video output. Four kinds of video outputs are available: TVI, AHD, CVI, and CVBS.

## 2 Installation

### Before you start

- Make sure that the device in the package is in good condition and all the assembly parts are included.
- Make sure that all the related equipment is power-off during the installation.
- Check the specification of the products for the installation environment.

- Check whether the power supply is matched with your power output to avoid damage.
- Make sure the wall is strong enough to withstand three times the weight of the camera and the mount.
- If the product does not function properly, contact your dealer or the nearest service center. DO NOT disassemble the camera for repair or maintenance by yourself.

## 2.1 Installation of Type I Camera

### 2.1.1 Ceiling/Wall Mounting Without Junction Box

#### **Before you start:**

Ceiling mounting and wall mounting are similar. Following steps take ceiling mounting as an example.

#### **Steps:**

1. Paste the drill template (supplied) to the place where you want to install the camera.
2. (Optional) For cement ceiling, drill the screw holes with a 5.5 mm drill and insert the supplied wall plugs.

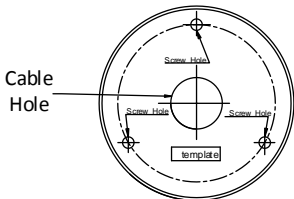

Figure 2-1 Drill Template

3. (Optional) Drill the cable hole, when the cables are routed through the ceiling.
4. Align the screw holes in the bracket to the ceiling, and secure the camera with three PA4 × 25 screws (supplied).

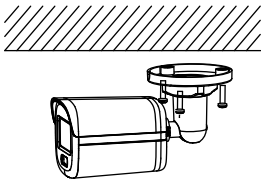

Figure 2-2 Secure the Camera to the Ceiling

5. Connect the power cord and video cable.
6. Power on the camera to check whether the image on the monitor is gotten from the optimum angle. If not, turn the trim ring counterclockwise to loosen it and adjust the positions according to the figure below.

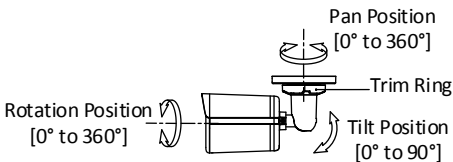

Figure 2-3 3-Axis Adjustment

7. Turn the trim ring clockwise to lock the positions.

## 2.1.2 Ceiling/Wall Mounting with Junction Box

### **Before you start:**

- You need to purchase a junction box in advance.
- Ceiling mounting and wall mounting are similar. Following steps take wall mounting as an example.

### **Steps:**

1. Paste the drill template for junction box to the place where you want to install the camera.
2. (Optional) For cement wall, drill the screw holes with a 5.5 mm drill and insert the supplied wall plugs.

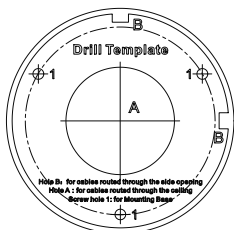

Figure 2-4 Drill Template for Junction Box

3. (Optional) Drill the cable hole, when the cables are routed through the wall.
4. Take apart the junction box.
5. Align the screw holes of the camera with those on the junction box cover. Attach the camera to the junction box cover with three PM4 × 10 screws.

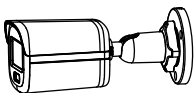

Figure 2-5 Attach the Camera to the Junction Box Cover

6. Secure the junction box body on the wall with three PA4 × 25 screws (supplied).

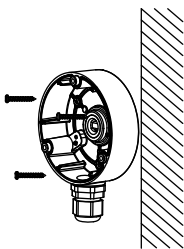
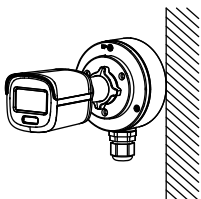

Figure 2-6 Secure the Junction Box on the Wall

7. Route the cables through the bottom cable hole or side cable hole of the junction box and connect the cables.
8. Fix the junction box cover on its body with three PM3 × 16 L6 screws that come with the junction box.





## Figure 2-7 Fix the Junction Box Cover on Its Body

- Repeat steps 6 to 7 of 2.1.1 *Ceiling/Wall Mounting Without Junction Box* to finish the installation.

## 2.2 Installation of Type II Camera

### 2.2.1 Ceiling/Wall Mounting Without Junction Box

#### **Before you start:**

Ceiling mounting and wall mounting are similar. Following steps take ceiling mounting as an example.

#### **Note:**

For installation with junction box, refers to 2.1.2 *Ceiling/Wall Mounting with Junction Box*.

#### **Steps:**

- Paste the drill template (supplied) to the place where you want to install the camera.
- (Optional) For cement ceiling, drill the screw holes with a 5.5 mm drill and insert the supplied wall plugs.

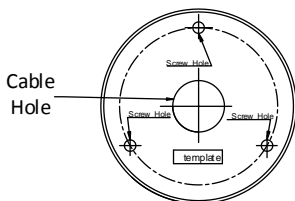

Figure 2-8 Drill Template

- (Optional) Drill the cable hole, when the cables are routed through the ceiling.
- Align the screw holes in the bracket to the ceiling, and secure the camera with three PA4 × 25 screws (supplied).

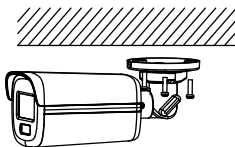

Figure 2-9 Secure the Camera to the Ceiling

- Connect the power cord and video cable.
- Power on the camera to check whether the image on the monitor is gotten from the optimum angle. If not, adjust the camera according to the figure below.

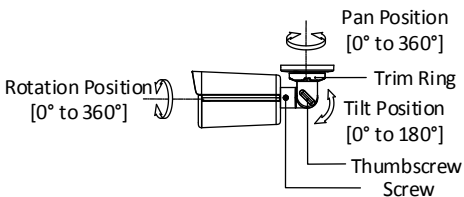

Figure 2-10 3-Axis Adjustment

- Loosen the trim ring to adjust the pan position [0° to 360°].
- Loosen the thumbscrew to adjust the tilt position [0° to 180°].

- 3). Loosen the screw to adjust the rotation position [0° to 360°].
7. Tighten the trim ring and screws to finish the installation.

## 2.3 Installation of Type III Camera

### 2.3.1 Ceiling Mounting Without Junction Box

#### Steps:

1. Paste the drill template (supplied) to the place where you want to install the camera.
2. (Optional) For cement ceiling, drill the screw holes with a 5.5 mm drill and insert the supplied wall plugs.



Figure 2-11 Drill Template

3. Attach the gang box to the ceiling and secure it with three PA4 × 25 screws (supplied).

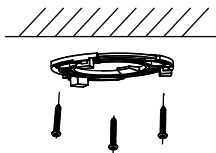

Figure 2-12 Attach the Gang Box to the Ceiling

4. Fit the camera onto the gang box.

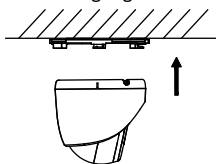

Figure 2-13 Fit the Camera onto the Gang Box

5. Turn the camera clockwise until it snaps into the gang box.

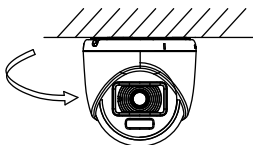

Figure 2-14 Snap the Camera into the Gang Box

6. Connect the power cord and video cable.
7. Power on the camera to check whether the image on the monitor is gotten from the optimum angle. If not, adjust the camera according to the figure below.

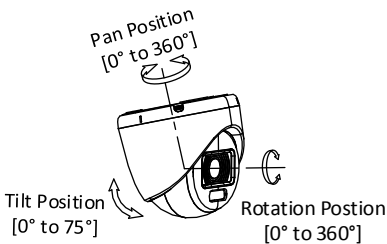

Figure 2-15 3-Axis Adjustment

- 1). Rotate the enclosure to adjust the pan position [0° to 360°].
- 2). Move the main body up and down to adjust the tilt position [0° to 75°].
- 3). Rotate the main body to adjust the rotation position [0° to 360°].

### 2.3.2 Ceiling Mounting with Junction Box

#### **Before you start:**

You need to purchase a junction box in advance.

#### **Steps:**

1. Loosen screws to take apart the junction box.
2. Paste the drill template for junction box to the place where you want to install the camera.
3. (Optional) For cement ceiling, drill the screw holes with a 5.5 mm drill and insert the supplied wall plugs.

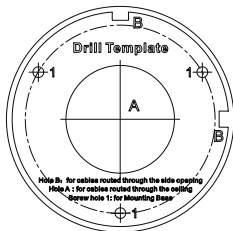

Figure 2-16 Drill Template for Junction Box

4. (Optional) Drill the cable hole, when the cables are routed through the ceiling.
5. Secure the junction box body on the ceiling with three PA4 × 25 screws that come with the junction box.

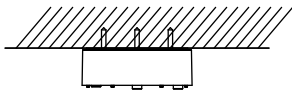

Figure 2-17 Secure the Junction Box Body

6. Route the cables through the bottom cable hole or the side cable hole of the junction box.
7. Combine the junction box cover with its body and secure it with screws.

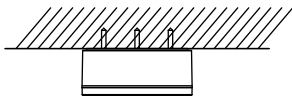

Figure 2-18 Combine the Junction Box Cover and Body

8. Fix the gang box onto the junction box cover with PA4 × 10 screws that come with the junction box.
9. Connect the power cord and video cable and put the cables back into the junction box.
10. Press the camera base to the gang box. Turn the camera clockwise until it snaps into the gang box.
11. Refer to step 6 of 2.4.1 *Ceiling Mounting Without Junction Box* to adjust the angle and finish the installation.

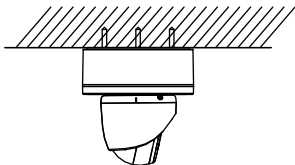

Figure 2-19 Finish the Installation

### 2.3.3 Wall Mounting

#### **Before you start:**

You need to purchase a wall mount in advance.

#### **Steps:**

1. Drill  $\Phi$  10 mm screw holes in the wall where you want to install the wall mount.
2. Use M6 × 75 metal expansion bolts to fix the wall mount onto the wall.

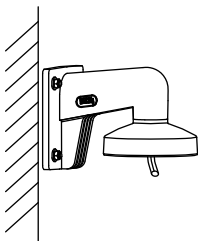

Figure 2-20 Fix the Wall Mount

3. Use PM4 × 10 screws to fix the gang box onto the wall mount.

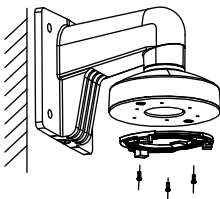

Figure 2-21 Fix the Gang Box

4. Repeat the step 4 to 6 of 2.4.1 *Ceiling Mounting Without Junction Box* to finish the installation.

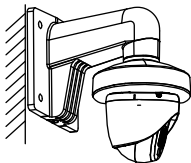

Figure 2-22 Finish the Installation

## 2.4 Installation of Type IV Camera

### 2.4.1 Ceiling Mounting Without Junction Box

#### Steps:

1. Loosen the set screw.
2. Rotate the camera to align the triangle mark with the screw hole, and disassemble the camera.

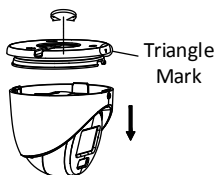

Figure 2-23 Disassemble the Camera

3. Paste the drill template (supplied) to the place where you want to install the camera.
4. (Optional) For cement ceiling, drill the screw holes with a 5.5 mm drill and insert the supplied wall plugs.

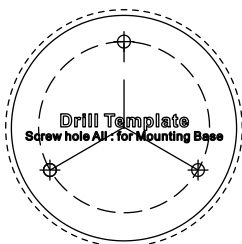

Figure 2-24 Drill Template

5. Use three PA4 × 25 screws (supplied) to secure the base to the ceiling.

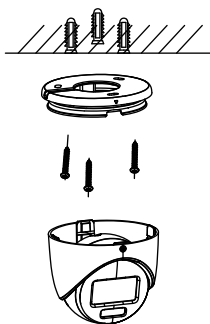

Figure 2-25 Secure the Base to the Ceiling

6. Align the screw hole with the triangle mark to install the camera back to the base and secure it.

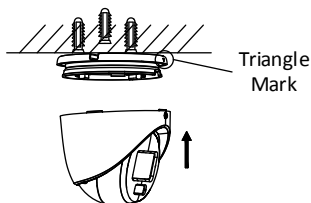

Figure 2-26 Install the Camera Back

7. Connect the power cord and video cable.
8. Power on the camera to check whether the image on the monitor is gotten from the optimum angle. If not, adjust the camera according to the figure below.

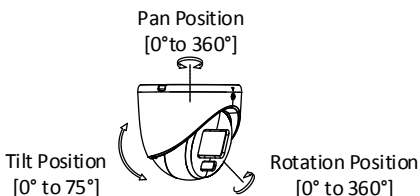

Figure 2-27 3-Axis Adjustment

- 1). Rotate the enclosure to adjust the pan position [0° to 360°].
  - 2). Move the main body up and down to adjust the tilt position [0° to 75°].
  - 3). Rotate the main body to adjust the rotation position [0° to 360°].
9. Tighten the set screw to finish the installation.

**Note:**

If you need to adjust the angle after installation, loosen the set screw first and then repeat step 8 to 9.

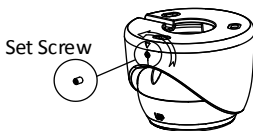

Figure 2-28 Loosen the Set Screw

## 2.4.2 Ceiling Mounting with Junction Box

### **Before you start:**

You need to purchase a junction box in advance.

### **Steps:**

1. Loosen screws to take apart the junction box.
2. Paste the drill template for junction box to the place where you want to install the camera.
3. (Optional) For cement ceiling, drill the screw holes with a 5.5 mm drill and insert the supplied wall plugs.

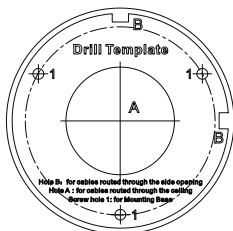

Figure 2-29 Drill Template for Junction Box

4. (Optional) Drill the cable hole, when the cables are routed through the ceiling.
5. Secure the junction box body on the ceiling with three PA4 × 25 screws that come with the junction box.

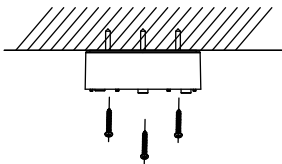

Figure 2-30 Secure the Junction Box Body

6. Route the cables through the bottom cable hole or the side cable hole of the junction box.
7. Combine the junction box cover with its body and secure it with three PM3 × 13 screws.

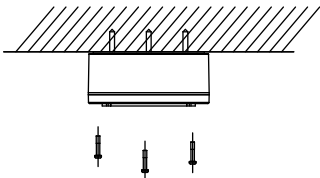

Figure 2-31 Combine the Junction Box Cover and Body

8. Fix the base onto the junction box cover with three M4 × 10 screws.

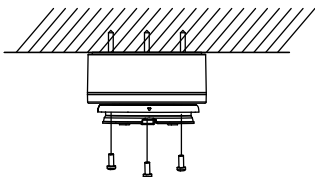

Figure 2-32 Fix the Base

9. Connect the power cord and video cable and put the cables back into the junction box.
10. Repeat the step 6, 8, and 9 of 2.4.1 *Ceiling Mounting Without Junction Box* to finish the installation.

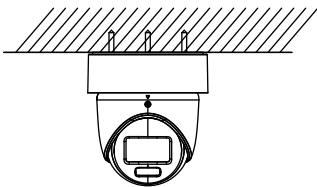

Figure 2-33 Finish the Installation

### 2.4.3 Wall Mounting

#### **Before you start:**

You need to purchase a wall mount in advance.

#### **Steps:**

1. Drill  $\Phi$  10 mm screw holes in the wall where you want to install the wall mount.
2. Use four M6 expansion bolts to fix the wall mount onto the wall.

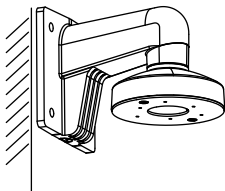

Figure 2-34 Fix the Wall Mount

- Loosen the set screw.
- Rotate the camera to align the triangle mark with the screw hole, and disassemble the camera.

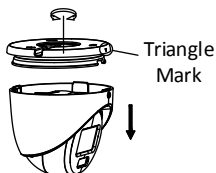

Figure 2-35 Disassemble the Camera

- Use M4 × 10 screws to fix the base onto the wall mount.

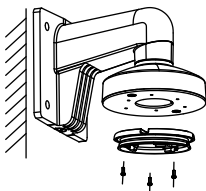

Figure 2-36 Fix the Base onto the Wall Mount

- Repeat steps 6 to 9 of 2.4.1 *Ceiling Mounting Without Junction Box* to finish the installation.

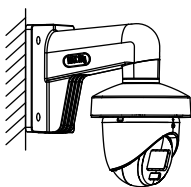

Figure 2-37 Finish the Installation

## 2.5 Installation of Type V Camera

### 2.5.1 Ceiling Mounting without Junction Box

#### Steps:

- Paste the drill template (supplied) to the place where you want to install the camera.
- (Optional) For cement ceiling, drill the screw holes with a 5.5 mm drill and insert the supplied wall plugs.



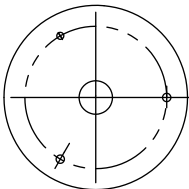

Figure 2-38 Drill Template

3. Attach the gang box to the ceiling and secure it with three PA4 × 25 screws (supplied).

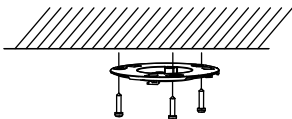

Figure 2-39 Attach the Gang Box to the Ceiling

4. Fit the camera onto the gang box.

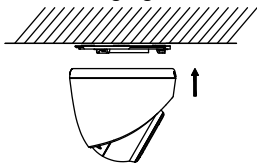

Figure 2-40 Fit the Camera

5. Turn the camera clockwise until it snaps into the gang box.

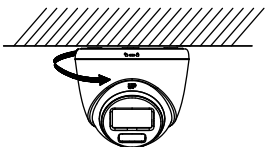

Figure 2-41 Snap the Camera into the Gang Box

6. Connect the power cord and video cable.
7. Power on the camera to check whether the image on the monitor is gotten from the optimum angle. If not, adjust the camera according to the figure below.

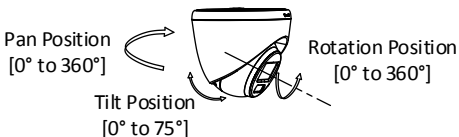

Figure 2-42 3-Axis Adjustment

- 1). Rotate the enclosure to adjust the pan position [0° to 360°].
- 2). Move the main body up and down to adjust the tilt position [0° to 75°].
- 3). Rotate the main body to adjust the rotation position [0° to 360°].

## 2.5.2 Ceiling Mounting with Junction Box/Inclined Ceiling Mount

### **Before you start:**

- You need to purchase a junction box or inclined ceiling mount in advance.

- Ceiling mounting with junction box and inclined ceiling mount are similar. Following steps take junction box as an example.

**Steps:**

1. Paste the drill template for junction box to the place where you want to install the camera.
2. (Optional) For cement ceiling, drill the screw holes with a 5.5 mm drill and insert the supplied wall plugs.

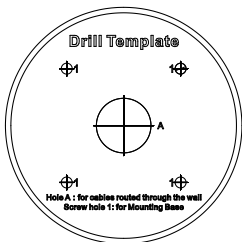

Figure 2-43 Drill Template

3. (Optional) Drill the cable hole, when the cables are routed through the wall.
4. Take apart the junction box.
5. Install the gang box to the junction box cover with three PM4 screws.

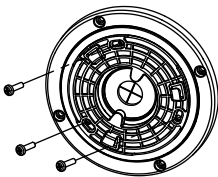

Figure 2-44 Install Gang Box to Junction Box Cover

6. Fit the camera onto the gang box.

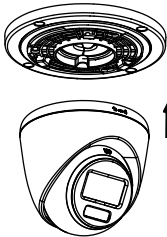

Figure 2-45 Fit the Camera

7. Turn the camera clockwise until it snaps into the gang box.



Figure 2-46 Snap the Camera into the Gang Box

8. Secure the junction box body on the ceiling with four PA4 × 25 screws.

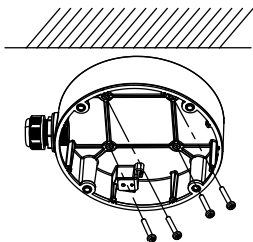

Figure 2-47 Secure the Junction Box Body

9. Route the cables through the bottom cable hole or the side cable hole of the junction box and connect the cables.
10. Combine the junction box cover with its body.

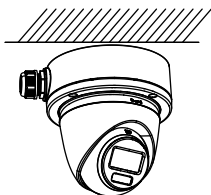

Figure 2-48 Combine Junction Box Cover with Body

11. Refer to step 7 of 2.4.1 *Ceiling Mounting Without Junction Box* to adjust the angle.

### 2.5.3 Wall Mounting

#### **Before you start:**

You need to purchase a wall mount in advance.

#### **Steps:**

1. Drill  $\Phi$  10 mm screw holes in the wall where you want to install the wall mount.
2. Use four M6 expansion bolts to fix the wall mount onto the wall.

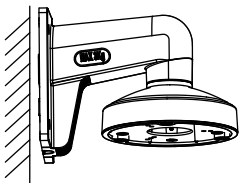

Figure 2-49 Fix the Wall Mount

3. Use three PM4  $\times$  10 screws to fix the gang box onto the wall mount.

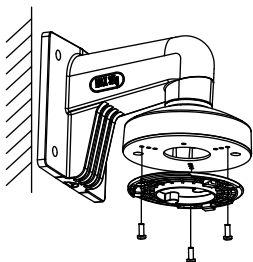

Figure 2-50 Fix the Gang Box

- Repeat the step 4 to 7 of 2.4.1 *Ceiling Mounting Without Junction Box* to finish the installation.



Figure 2-51 Finish the Installation

## 3 Waterproof Measures

---

If the camera is installed outdoor, you should use the waterproof tapes to waterproof the cables. Otherwise the cables might get wet or a short circuit occurs.

**Note:**

Waterproof tapes should be purchased separately.

After routing and connecting the cables, use the waterproof tapes to wrap up the cables. Connected cables and spare cables both should be wrapped up as the figures below.

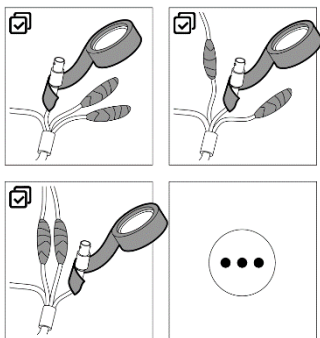

Figure 3-1 Waterproof Cables

## 4 Menu Description

---

Please follow the steps below to call the menu.

**Note:**

The actual display may vary with your camera model.

**Steps:**

- Connect the camera with the TVI DVR and the monitor, as shown in figure 3-1.



Figure 4-1 Connection

- Power on the camera, TVI DVR, and monitor to view the image on the monitor.
- Click PTZ Control to enter the PTZ Control interface.

4. Call the camera menu by clicking  button or calling preset No. 95.

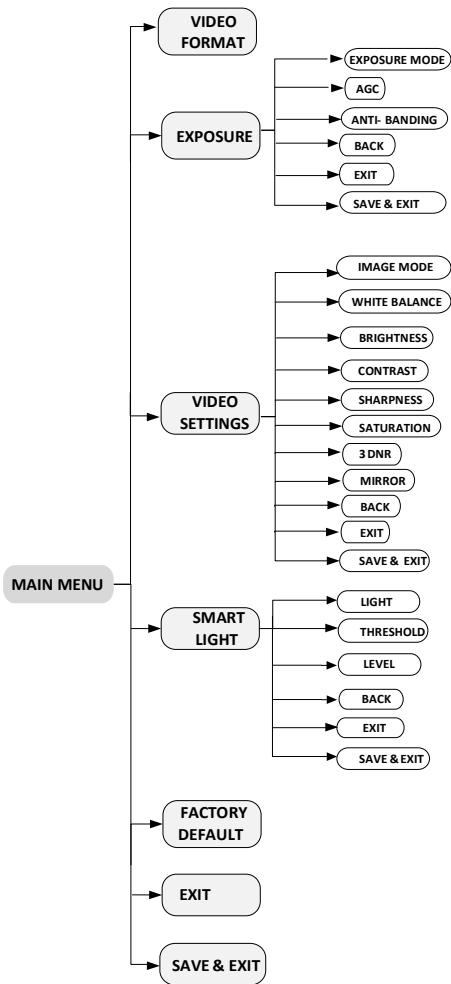

Figure 4-2 Main Menu Overview

5. Click the direction buttons to control the camera.
- 1). Click up/down direction buttons to select menu options.
  - 2). Click Iris + to confirm the selection.
  - 3). Click left/right direction buttons to adjust the value of the selected option.

## 4.2 VIDEO FORMAT

You can set the video format to 2MP@25fps, 2MP@30fps, PAL, or NTSC.

## 4.3 EXPOSURE

### EXPOSURE MODE

You can set the **EXPOSURE MODE** to **GLOBAL**, **BLC**, **HLC**, or **DWDR**.

- **GLOBAL**

GLOBAL refers to the normal exposure mode which adjusts lighting distribution, variations, and non-standard processing.

- **BLC (Backlight Compensation)**

BLC (Backlight Compensation) compensates light to the object in the front to make it clear, but this may cause over-exposure of the background where the light is strong.

- **HLC (Highlight Compensation)**

HLC stands for highlight compensation. The camera detects strong spots (over-exposure portion of image) and reduces the brightness of strong spots to improve the overall images.

- **DWDR (Digital Wide Dynamic Range)**

Digital wide dynamic range gives the camera the ability to view dark areas of given image as well as extremely lighted portions of the image or areas of high contrast.

**AGC (Auto Gain Control)**

It optimizes the clarity of the image in poor light conditions. The **AGC** level can be set to **HIGH**, **MEDIUM**, or **LOW**.

**Note:**

The noise will be amplified when setting the **AGC** level.

**ANTI-BANDING**

**ANTI-BANDING** is a camera setting that prevents the appearance of horizontal lines (banding) when photographing images in low frequency light and high brightness environments.

#### 4.4 VIDEO SETTINGS

Move the cursor to **VIDEO SETTINGS** and click Iris+ to enter the submenu. **IMAGE MODE**, **WHITE BALANCE**, **BRIGHTNESS**, **CONTRAST**, **SHARPNESS**, **SATURATION**, **3DNR**, and **MIRROR** are adjustable.

VIDEO SETTINGS	
IMAGE MODE	◀ STD ▶
WHITE BALANCE	↵
BRIGHTNESS	◀ 5 ▶
CONTRAST	◀ 5 ▶
SHARPNESS	◀ 5 ▶
SATURATION	◀ 5 ▶
3DNR	◀ 5 ▶
MIRROR	◀ OFF ▶
BACK	↵
EXIT	↵
SAVE & EXIT	↵

Figure 4-3 VIDEO SETTINGS

#### IMAGE MODE

**IMAGE MODE** is used to adjust the image saturation, and you can set it to **STD** (Standard), **HIGH-SAT** (High Saturation), or **HIGHLIGHT** (better indoor facial details).

#### WHITE BALANCE

White balance, the white rendition function of the camera, is to adjust the color temperature according to the environment. It can remove unrealistic color casts in the image. You can set **WHITE BALANCE** mode to **AUTO** or **MANUAL**.

- **AUTO**

Under **AUTO** mode, white balance is being adjusted automatically according to the color temperature of the scene illumination.

- **MANUAL**

You can adjust the **R-GAIN** and **B-GAIN** value to correct colors manually.

WHITE BALANCE	
MODE	◀ MANUAL ▶
R-GAIN	◀ 5 ▶
B-GAIN	◀ 5 ▶
BACK	↵
EXIT	↵
SAVE&EXIT	↵

Figure 4-4 WHITE BALANCE

### **BRIGHTNESS**

Brightness refers to the brightness of the image. You can set the brightness value from 1 to 9 to darken or brighten the image. The greater the value is, the brighter the image is.

### **CONTRAST**

This feature enhances the difference in color and light between parts of an image.

### **SHARPNESS**

Sharpness determines the amount of detail an imaging system can reproduce.

### **SATURATION**

Saturation is the proportion of pure chromatic color in the total color sensation. Adjust this feature to change the saturation of the color.

### **3DNR (3D DNR)**

3DNR refers to 3D digital noise reduction. Comparing with the general 2D digital noise reduction, the 3D digital noise reduction function processes the noise between two frames besides processing the noise in one frame. The noise will be much less and the video will be clearer.

### **MIRROR**

**OFF**, **H**, **V**, and **HV** are selectable for mirror.

**OFF**: The mirror function is disabled.

**H**: The image flips 180° horizontally.

**V**: The image flips 180° vertically.

**HV**: The image flips 180° both horizontally and vertically.

## **4.5 SMART LIGHT**

**SMART LIGHT** is used to control the integrated white light and avoid overexposure when the light is on. You can set the light as **AUTO** or **OFF**.

SMART LIGHT	
LIGHT	◀ AUTO ▶
THRESHOLD	◀ 2 ▶
LEVEL	◀ 5 ▶
BACK	↵
EXIT	↵
SAVE & EXIT	↵

Figure 4-5 SMART LIGHT

- **AUTO**

Under the **AUTO** mode, the white light turns on automatically as the environment becomes dark.

The **THRESHOLD** is the environmental light level at which the white light turns on. The greater the value is,

the darker the environment is when the light is activated.

The value of **LEVEL** controls the brightness of the white light. The greater the value is, the brighter the light is.

- **OFF**

The white light is always off except when alarm is set and triggered.

#### **4.6 FACTORY DEFAULT**

Reset all the settings to factory defaults.

#### **4.7 EXIT**

Move the cursor to **EXIT** and click Iris+ to exit the menu.

#### **4.8 SAVE & EXIT**

Move the cursor to **SAVE & EXIT** and click Iris+ to save the settings and exit the menu.

**UD17669B-B**